



# USER MANUAL

# *ProLite*

## LCD Monitor

### *ProLite E4835*

Thank you very much for choosing the iiyama LCD monitor.  
We recommend that you take a few minutes to read carefully through this brief but comprehensive manual before installing and switching on the monitor. Please keep this manual in a safe place for your future reference.

ENGLISH

DEUTSCH

FRANCAIS

ITALIANO

簡体中文

日本語





### **Congratulations!**

You have just purchased a TCO'99 approved and labelled product! Your choice has provided you with a product developed for professional use. Your purchase has also contributed to reducing the burden on the environment and also to the further development of environmentally adapted electronics products.

### **Why do we have environmentally labelled computers?**

In many countries, environmental labelling has become an established method for encouraging the adaptation of goods and services to the environment. The main problem, as far as computers and other electronics equipment are concerned, is that environmentally harmful substances are used both in the products and during their manufacture. Since it is not so far possible to satisfactorily recycle the majority of electronics equipment, most of these potentially damaging substances sooner or later enter nature.

There are also other characteristics of a computer, such as energy consumption levels, that are important from the viewpoints of both the work (internal) and natural (external) environments. Since all methods of electricity generation have a negative effect on the environment (e.g. acidic and climate-influencing emissions, radioactive waste), it is vital to save energy. Electronics equipment in offices is often left running continuously and thereby consumes a lot of energy.

### **What does labelling involve?**

This product meets the requirements for the TCO'99 scheme which provides for international and environmental labelling of personal computers. The labelling scheme was developed as a joint effort by the TCO (The Swedish Confederation of Professional Employees), Svenska Naturskyddsforeningen (The Swedish Society for Nature Conservation) and Statens Energimyndighet (The Swedish National Energy Administration).

Approval requirements cover a wide range of issues: environment, ergonomics, usability, emission of electric and magnetic fields, energy consumption and electrical and fire safety.

The environmental demands impose restrictions on the presence and use of heavy metals, brominated and chlorinated flame retardants, CFCs (freons) and chlorinated solvents, among other things. The product must be prepared for recycling and the manufacturer is obliged to have an environmental policy which must be adhered to in each country where the company implements its operational policy.

The energy requirements include a demand that the computer and/or display, after a certain period of inactivity, shall reduce its power consumption to a lower level in one or more stages. The length of time to reactivate the computer shall be reasonable for the user.

Labelled products must meet strict environmental demands, for example, in respect of the reduction of electric and magnetic fields, physical and visual ergonomics and good usability.

Below you will find a brief summary of the environmental requirements met by this product. The complete environmental criteria document may be ordered from:

#### **TCO Development**

SE-114 94 Stockholm, Sweden

Fax: +46 8 782 92 07

Email (Internet): [development@tco.se](mailto:development@tco.se)

Current information regarding TCO'99 approved and labelled products may also be obtained via the Internet, using the address: <http://www.tco-info.com/>



## Environmental requirements

### Flame retardants

Flame retardants are present in printed circuit boards, cables, wires, casings and housings. Their purpose is to prevent, or at least to delay the spread of fire. Up to 30% of the plastic in a computer casing can consist of flame retardant substances. Most flame retardants contain bromine or chloride, and those flame retardants are chemically related to another group of environmental toxins, PCBs. Both the flame retardants containing bromine or chloride and the PCBs are suspected of giving rise to severe health effects, including reproductive damage in fish-eating birds and mammals, due to the bio-accumulative\* processes. Flame retardants have been found in human blood and researchers fear that disturbances in foetus development may occur.

The relevant TCO'99 demand requires that plastic components weighing more than 25 grams must not contain flame retardants with organically bound bromine or chlorine. Flame retardants are allowed in the printed circuit boards since no substitutes are available.

### Cadmium\*\*

Cadmium is present in rechargeable batteries and in the colour-generating layers of certain computer displays. Cadmium damages the nervous system and is toxic in high doses. The relevant TCO'99 requirement states that batteries, the colour-generating layers of display screens and the electrical or electronics components must not contain any cadmium.

### Mercury\*\*

Mercury is sometimes found in batteries, relays and switches. It damages the nervous system and is toxic in high doses. The relevant TCO'99 requirement states that batteries may not contain any mercury. It also demands that mercury is not present in any of the electrical or electronics components associated with the labelled unit.

### CFCs (freons)

The relevant TCO'99 requirement states that neither CFCs nor HCFCs may be used during the manufacture and assembly of the product. CFCs (freons) are sometimes used for washing printed circuit boards. CFCs break down ozone and thereby damage the ozone layer in the stratosphere, causing increased reception on earth of ultraviolet light with e.g. increased risks of skin cancer (malignant melanoma) as a consequence.

### Lead\*\*

Lead can be found in picture tubes, display screens, solders and capacitors. Lead damages the nervous system and in higher doses, causes lead poisoning. The relevant TCO'99 requirement permits the inclusion of lead since no replacement has yet been developed.

---

\* *Bio-accumulative is defined as substances which accumulate within living organisms*

\*\* *Lead, Cadmium and Mercury are heavy metals which are Bio-accumulative.*



ENGLISH

## FCC DECLARATION OF CONFORMITY

**Model Number:** PLE483S  
**Trade Name:** iiyama  
**Responsible party:** Iiyama North America, Inc.  
**Address:** 65 West Street Road, Suite 101B, Warminster, PA 18974 U.S.A.  
**Telephone number:** 215-682-9050

This device complies with Part 15 of the FCC Rules. Operation is subject to the following two conditions: (1) This device may not cause harmful interference, and (2) this device must accept any interference received, including interference that may cause undesired operation.

This device has been tested and found to comply with the limits for Class B Personal Computers and peripherals, pursuant to Part 15 of the FCC Rules. These limits are designed to provide reasonable protection against harmful interference when the device is operated in a residential environment. This device generates, uses and can radiate radio frequency energy, and if not installed and used in accordance with the instructions, may cause harmful interference to radio communications. However, there is no guarantee that interference will not occur in a particular installation. If you determine the device does cause harmful interference to radio or television reception (this may be determined by monitoring the interference while turning the device off and on), you are encouraged to try to correct the interference by one of the following measures:

- Reorient or relocate the receiving antenna.
- Increase the separation between the device and receiver.
- Connect the device into an outlet on a circuit different from that to which the receiver is connected.
- Consult the dealer or an experienced radio or TV technician for help.

To meet the FCC requirements, you should use a signal cable with ferrite core at both ends.

**CAUTION** Changes or modifications not expressly approved by Iiyama could void the users authority to operate the device under FCC compliance regulations.

## CANADIAN DEPARTMENT OF COMMUNICATIONS COMPLIANCE STATEMENT

This digital apparatus does not exceed the Class B limits for radio noise emissions from digital apparatus as set out in the radio interference regulation of the Canadian department of communications.

## CE MARKING DECLARATION OF CONFORMITY

This LCD monitor complies with the requirements of the EC Directive 89/336/EEC "EMC Directive" and 73/23/EEC "Low Voltage Directive" as amended by Directive 93/68/EEC.

The electro-magnetic susceptibility has been chosen at a level that gives correct operation in residential areas, business and light industrial premises and small-scale enterprises, inside as well as outside of the buildings. All places of operation are characterised by their connection to the public low voltage power supply system.

- We reserve the right to change specifications without notice.
- All trademarks used in this user manual are the property of their respective owners.
- As an ENERGY STAR® Partner, Iiyama has determined that this product meets the ENERGY STAR® guidelines for energy efficiency.



# TABLE OF CONTENTS

FOR YOUR SAFETY .....	1
SAFETY PRECAUTIONS .....	1
SPECIAL NOTES ON LCD MONITORS .....	3
CUSTOMER SERVICE .....	3
CLEANING .....	3
BEFORE YOU OPERATE THE MONITOR .....	4
CHECKING THE CONTENTS OF THE PACKAGE .....	4
HOW TO USE THE STAND .....	4
HOW TO UNINSTALL THE STAND .....	5
COMPUTER SETTING .....	6
ADJUSTING THE VIEWING ANGLE .....	6
FRONT PANEL CONTROL .....	7
INSTALLATION .....	7
OPERATING THE MONITOR .....	8
USING OSD FUNCTION .....	8
MAIN MENU .....	8
ADJUSTING .....	8
CARE AND MAINTENANCE .....	16
TROUBLE SHOOTING .....	17
APPENDIX .....	18
SPECIFICATIONS .....	18
DIMENSIONS .....	19
COMPLIANT TIMING .....	19
CONNECTOR PIN ASSIGNMENT .....	20

ENGLISH





## FOR YOUR SAFETY

### SAFETY PRECAUTIONS

#### WARNING

##### STOP OPERATING THE MONITOR WHEN YOU SENSE TROUBLE

If you notice any abnormal phenomena such as smoke, strange sounds or fumes, unplug the monitor and contact your dealer or iiyama service center immediately. Further use may be dangerous and can cause fire or electric shock.

##### NEVER REMOVE THE CABINET

High voltage circuits are inside the monitor. Removing the cabinet may expose you to the danger of fire or electric shock.

##### DO NOT PUT ANY OBJECT INTO THE MONITOR

Do not put any solid objects or liquids such as water into the monitor. In case of an accident, unplug your monitor immediately and contact your dealer or iiyama service center. Using the monitor with any object inside may cause fire, electric shock or damage.

##### INSTALL THE MONITOR ON A FLAT, STABLE SURFACE

The monitor may cause an injury if it falls or is dropped.

##### DO NOT USE THE MONITOR NEAR WATER

Do not use where water may be splashed or spilt onto the monitor as it may cause fire or electric shock.

##### OPERATE UNDER THE SPECIFIED POWER SUPPLY

Be sure to operate the monitor only with the specified power supply. Use of an incorrect voltage will cause malfunction and may cause fire or electric shock.

##### PROTECT THE CABLES

Do not pull or bend the power cable and signal cable. Do not place the monitor or any other heavy objects on the cables. If damaged, the cables may cause fire or electric shock.

##### ADVERSE WEATHER CONDITIONS

It is advisable not to operate the monitor during a heavy thunder storm as the continual breaks in power may cause malfunction. It is also advised not to touch the plug in these circumstances as it may cause electric shock.



## CAUTION

### INSTALLATION LOCATION

Do not install the monitor where sudden temperature changes may occur, or in humid, dusty or smoky areas as it may cause fire, electric shock or damage. You should also avoid areas where the sun shines directly on the monitor.

### DO NOT PLACE THE MONITOR IN A HAZARDOUS POSITION

The monitor may topple and cause injury if not suitably located. Please also ensure that you do not place any heavy objects on the monitor, and that all cables are routed such that children may not pull the cables and possibly cause injury.

### MAINTAIN GOOD VENTILATION

Ventilation slots are provided to keep the monitor from overheating. Covering the slots may cause fire. To allow adequate air circulation, place the monitor at least 10 cm (or 4 inches) from any walls. Do not remove the tilt stand when operating the monitor. Ventilation slots on the back of the cabinet will be blocked and the monitor may overheat if the stand is removed. This may cause fire or damage. Operating the monitor on its back, side, upside down or on a carpet or any other soft material may also cause damage.

### DISCONNECT THE CABLES WHEN YOU MOVE THE MONITOR

When you move the monitor, turn off the power switch, unplug the monitor and be sure the signal cable is disconnected. If you do not disconnect them, it may cause fire or electric shock.

### UNPLUG THE MONITOR

If the monitor is not in use for a long period of time it is recommended that it is left unplugged to avoid accidents.

### HOLD THE PLUG WHEN DISCONNECTING

To disconnect the power cable or signal cable, always pull it by the plug. Never pull on the cable itself as this may cause fire or electric shock.

### DO NOT TOUCH THE PLUG WITH WET HANDS

Pulling or inserting the plug with wet hands may cause electric shock.

### WHEN YOU INSTALL THE MONITOR ON YOUR COMPUTER

Be sure the computer is strong enough to hold the weight of the monitor, otherwise, you may damage your computer.

### DO NOT PUT FLOPPY DISKS NEAR THE SPEAKERS

Magnetically recorded data, such as on a floppy disk, may become corrupted by the magnetic field produced by the speakers if the disks are placed on or near the speakers.

## OTHERS

### ERGONOMIC RECOMMENDATIONS

To eliminate eye fatigue, do not operate the monitor against a bright background or in a dark room. For optimal viewing comfort, the monitor should be just below eye level and 40-60 cm (16-24 inches) away from your eyes. When using the monitor over a prolonged time, a ten minute break every hour is recommended as looking at the screen continuously can cause eye strain.



## SPECIAL NOTES ON LCD MONITORS

The following symptoms are normal with LCD monitors and do not indicate a problem.

### NOTE

- When you first turn on the LCD monitor, the picture may not fit in the display area because of the type of computer that is used. In this case, adjust the picture position to the correct position.
- Due to the nature of the backlight, the screen may flicker during initial use. Turn off the Power Switch and then turn it on again to make sure the flicker disappears.
- You may find slightly uneven brightness on the screen depending on the desktop pattern you use.
- Due to the nature of the LCD screen, an afterimage of the previous screen may remain after switching the image, when the same image is displayed for hours. In this case, the screen is recovered slowly by changing the image or turning off the Power Switch for hours.
- Contact your dealer or iiyama service center for the backlight replacement when the screen is dark, flickering or not lighting up. Never attempt to replace it by yourself.

## CUSTOMER SERVICE

### NOTE

- The fluorescent light used in the LCD monitor may have to be periodically replaced. For the warranty coverage on this component, please check with local iiyama service center.
- If you have to return your unit for service and the original packaging has been discarded, please contact your dealer or iiyama service center for advice or replacement packaging.

## CLEANING

### WARNING

- If you drop any materials or liquids such as water into the monitor when cleaning, unplug the power cable immediately and contact your dealer or iiyama service center.

### CAUTION

- For safety reasons, turn off the power switch and unplug the monitor before you clean it.

### NOTE

- To protect the LCD panel, do not scratch or rub the screen with a hard object.
- Never use any of the following strong solvents. These will damage the cabinet and the LCD screen.
 

Thinner	Spray-type cleaner
Benzine	Wax
Abrasive cleaner	Acid or Alkaline solvent
- Touching the cabinet with any product made from rubber or plastic for a long time may cause degeneration or loss of paint on the cabinet.

### CABINET

Stains can be removed with a cloth lightly moistened with a mild detergent solvent. Then wipe the cabinet with a soft dry cloth.

### LCD

Periodic cleaning with a soft dry cloth is recommended.

### SCREEN

Don't use tissue paper etc. because these will damage the LCD screen.





## BEFORE YOU OPERATE THE MONITOR

### CHEKING THE CONTENTS OF THE PACKAGE

The following accessories are included in your package. Check to see if they are enclosed with the monitor. If anything is missing or damaged, please contact your local Iiyama dealer or regional Iiyama office.

- Power Cable\*                      ■ User Manual
- D-Sub Signal Cable            ■ Audio Cable

**CAUTION** \* The rating of the Power Cable enclosed in 120V area is 10A/125V. If you are using a power supply higher than this rating, then a power cable with a rating of 10A/250V must be used. However, all guarantees and warranties are void for any problems or damage caused by a power cable not supplied by Iiyama.

### HOW TO USE THE STAND

The monitor is the design that a stand rotate. Be sure to rotate the stand before operating the monitor, and rotate the stand upward before you re-box the monitor.

- CAUTION**
- Install the Stand on a stable surface. The monitor may cause injury or damage if it falls or is dropped.
  - Do not give a strong impact to the monitor. It may cause damage.
  - Unplug the monitor before installation to avoid electric shock or damage.

ENGLISH



(Fig 1)



(Fig 2)



(Fig 3)



(Fig 4)

1. Lay the monitor flat on a table with front face down (see Fig 1). Put a piece of soft cloth on the table beforehand to prevent the monitor from being scratched.
2. Unpack the stand and mount it onto the monitor base with aligning it to the hook (see Fig 2).
3. Slide the stand upward until it makes a click sound, indicating it is fixed (see Fig 3).
4. Stand the monitor up (see Fig 4).



## HOW TO UNINSTALL THE STAND



(Fig 1)



(Fig 2)

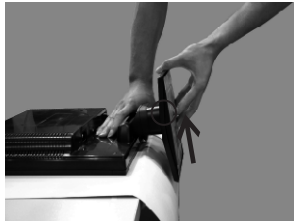

(Fig 3)



(Fig 4)

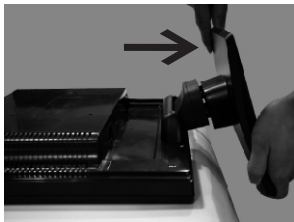

(Fig 5)

ENGLISH

1. Lay the monitor flat on a table with the LCD screen face down (see Fig 1). To prevent the monitor from being scratched, put a piece of soft cloth on the table on which the screen will be set.
2. Locate the hook on the stand (see Fig 2).
3. Hold the monitor and stand with both hands, and then slowly push the hook up, do not loose (see Fig 3).
4. Hold the monitor firmly with one hand and slide the stand downward with the other hand (see Fig 4). Make sure you slide the stand down slowly or you may damage both the monitor and the stand (see Fig 5).
5. Then, you shall successfully uninstall the stand.



## COMPUTER SETTING

### ■ Signal Timing

Change to the desired signal timing listed on page 19: COMPLIANT TIMING.

### ■ Windows 95/98/2000/Me/XP Plug & Play

The iiyama LCD monitor complies with DDC1/2B of VESA standard. The Plug & Play function runs on Windows 95/98/2000/Me/XP by connecting the monitor to DDC1/2B compliant computer with the Signal Cable supplied.

For installation on Windows 95/98/2000/Me/XP: The monitor Information File for iiyama monitors may be necessary for your computer and obtained via the Internet, using the address:

<http://www.iiyama.com>

### NOTE

- For additional information on how to download the driver for your touch screen monitor, please access the internet site noted above.
- Monitor Drivers are not required in most cases for Macintosh or Unix operating systems. For further information, please contact your computer dealer first for advice.

ENGLISH

## ADJUSTING THE VIEWING ANGLE

- For optimal viewing it is recommended to look at the full face of the monitor.
- Hold the stand so that the monitor does not topple when you change the monitor's angle.
- You are able to adjust the monitor's angle up to 20 degrees backward. (The indication of 20 degrees: tilted LCD panel holds for a moment at this point. Tilt the panel gently; using too much force can easily cause the tilt angle to exceed 20 degrees.)
- In order to ensure a healthy and relaxed body position when using the monitor at visual display workstations, it is recommended that the adjusted tilt angle should not exceed 10 degrees. Adjust the monitor's angle to your own preference.
  - Do not touch the LCD screen when you change the angle. It may cause damage or break the LCD screen.
  - Careful attention is required not to catch your fingers or hands when you change the angle.
  - Do not tilt the post beyond 20 degrees except when repacking the monitor in its box. To do so may cause the monitor to fall over and break.

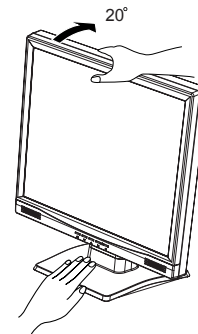
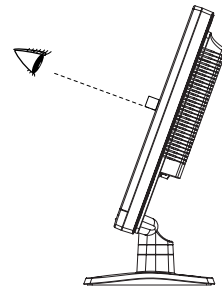



## FRONT PANEL CONTROL

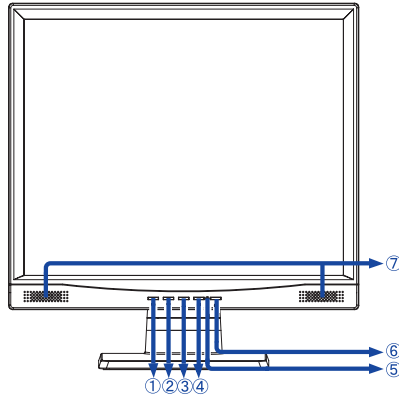

- |                        |                           |
|------------------------|---------------------------|
| ① ACTIVATE/EXIT OSD    | ② SCROLL DOWN / DECREASE  |
| ③ SCROLL UP / INCREASE | ④ SELECT DESIRED FUNCTION |
| ⑤ LED INDICATOR        | ⑥ POWER ON / OFF          |
| ⑦ SPEAKERS             |                           |

## INSTALLATION

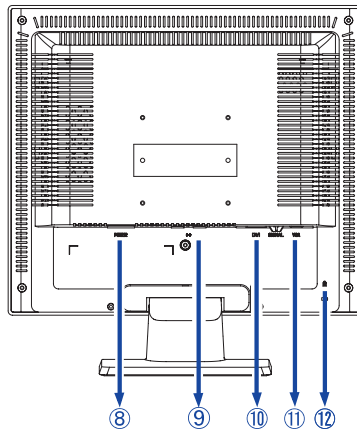

- |                             |                                   |
|-----------------------------|-----------------------------------|
| ⑧ AC CONNECTOR (AC IN)      | ⑨ AUDIO CONNECTOR                 |
| ⑩ DVI-D-24PINCONNECTOR(DVI) | ⑪ D-SUB MINI 15PIN CONNECTOR(VGA) |
| ⑫ KEYHOLE FOR SECURITY LOCK |                                   |

**NOTE** You can fasten a security lock and cable to prevent the monitor from being removed without your permission.

7 BEFORE YOU OPERATE THE MONITOR



## OPERATING THE MONITOR

### USING OSD FUNCTION

1. Press the **●** button to display the main menu shown below.
2. Press the **▲** or **▼** button to scroll to the desired menu option.
3. Press the **●** button to select the menu option.
4. Press the **▲** or **▼** button to select submenu option.
5. After making adjustment, press **●** button to save changes and exit the screen.

### MAIN MENU



### ADJUSTING



**Auto Adjust:** Auto adjust horizontal position, vertical position, phase (Fine Tune) and Clock (H.Size).

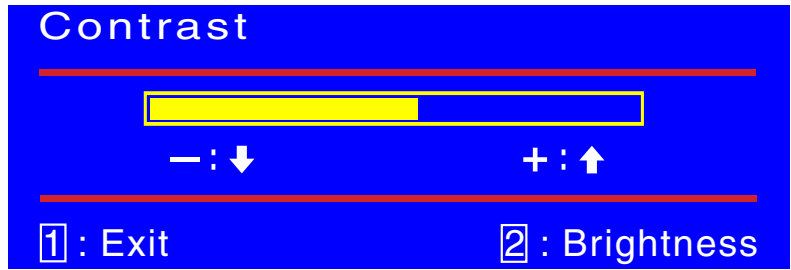

**Contrast:** To adjust the foreground white level of screen image.

▲ : increase contrast, ▼ : decrease contrast.

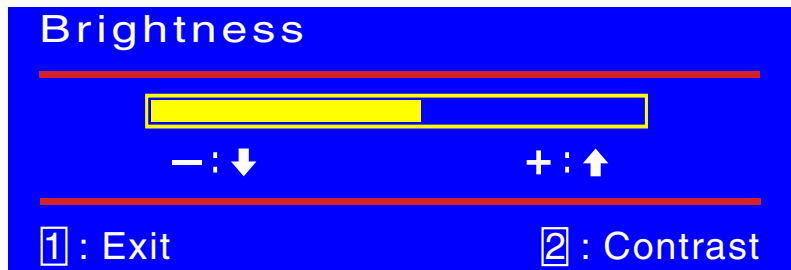

**Brightness:** To adjust the background black level of screen image.

▲ : increase brightness, ▼ : decrease brightness.



**Color Adjust:** Provides four preset color adjustments:

9300K, 6500K, 5400K and User Color for improved brightness and color saturation. Press button  to select the preset color.

9300K—Adds blue to screen image for cooler white.

6500K—Adds red to screen image for warmer white and richer red.

5400K—Adds green to screen image for a darker color.

ENGLISH





### User Color

**R**

**G**

**B**

- : ↓                      + : ↑

[1] : Exit                      [2] : Select

**User Color:** Individual adjustments for red(R), green (G), blue (B).

1. Press button to set adjustment and select next color to adjust.
2. Press or button to adjust selected color.

### Information

H.Frequency: 79.99 kHz

V.Frequency: 75.03 Hz

Pixel Clock: 135.04 MHz

Resolution: 1280 x 1024

Model Number: PLE483

Serial No: 1007130001001

[1] : Exit

**Information:** Displays information regarding the current input signal coming from the graphic card in your computer.

**NOTE** See your graphic card user guide for more information about changing the resolution and refresh.

ENGLISH



**Image Adjust:** Adjust Horizontal/ Vertical position, H. Size, Fine Tune and Sharpness.

ENGLISH

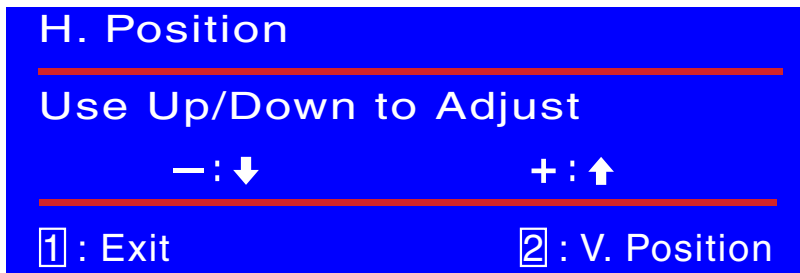

**H./V. Position:** To adjust the horizontal and vertical position of the video.

H. Position: ▲ : moves screen to right, ▼ : moves screen to left.

V. Position: ▲ : moves screen to up, ▼ : moves screen to down.

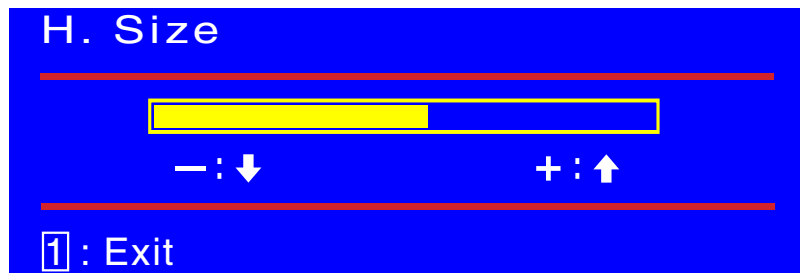

**H.Size:** Adjusts the width of screen image.

▼ decreases width of screen image, ▲ increases width of screen image.





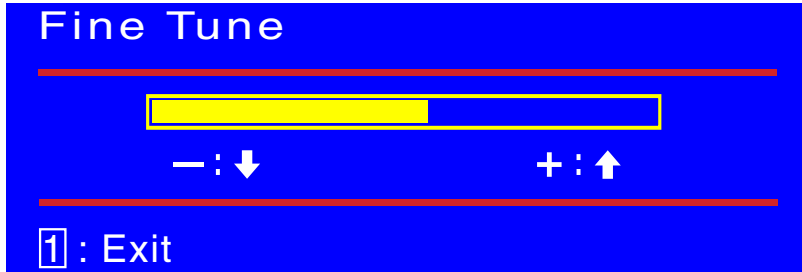

**Fine Tune:** To adjust the delay time.  
Press ▲ or ▼ to adjust to user preference.

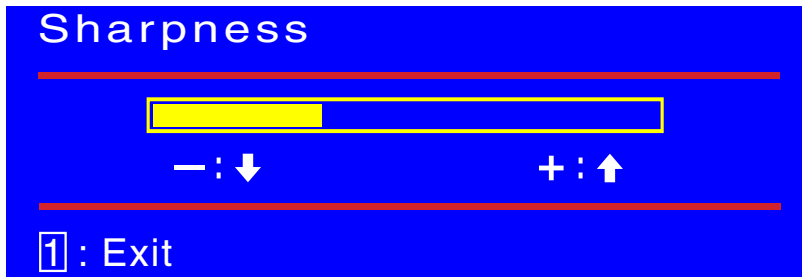

**Sharpness:** Adjusts the clarity of a non-SXGA (1280x1024) signal.  
Press ▲ or ▼ button to adjust.

ENGLISH

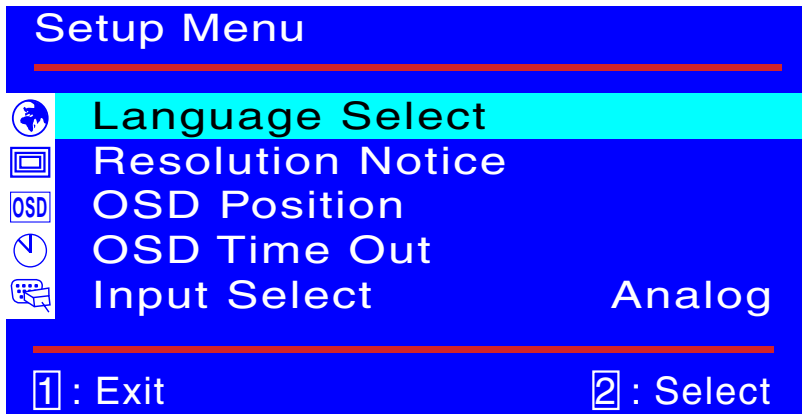

**Setup Menu:** To setting Language Select, Resolution Notice, OSD position, OSD Time Out and Input Select(Analog).



ENGLISH

**Language Select:** Allows the user to choose from available languages.

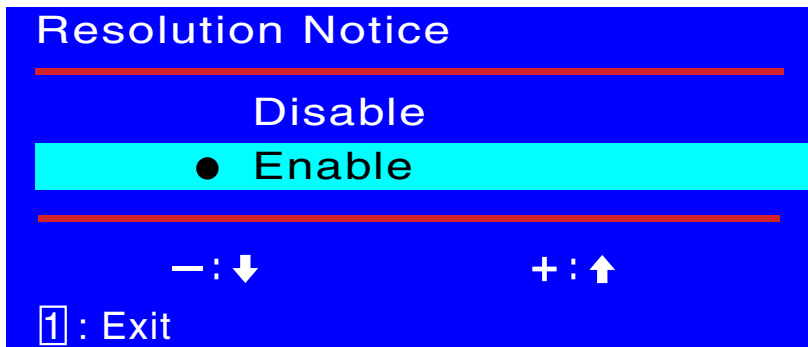

**Resolution Notice:** There is a OSD message of "For best picture quality change resolution to "1280 x 1024" displayed on the screen after 30 seconds Powering ON or changing mode to lower resolutions (640 x 480/ 720 x 400/ 800 x 600/ 1024x768), if the function was "enable". Above message would not display on screen if it was "disable".



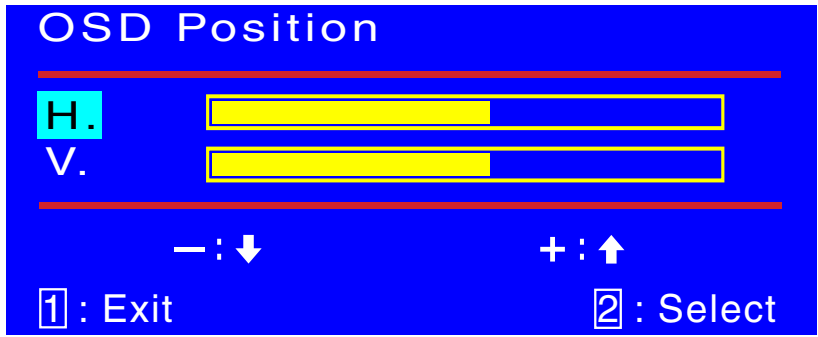

**OSD Position:** Press the **OSD** button to select the horizontal or vertical OSD position.  
**Horizontal OSD Position** horizontally repositions all OSD screens.  
▲ moves OSD right, ▼ moves OSD left.  
**Vertical OSD Position** vertically repositions all OSD screen.  
▲ moves OSD up, ▼ moves OSD down.

ENGLISH

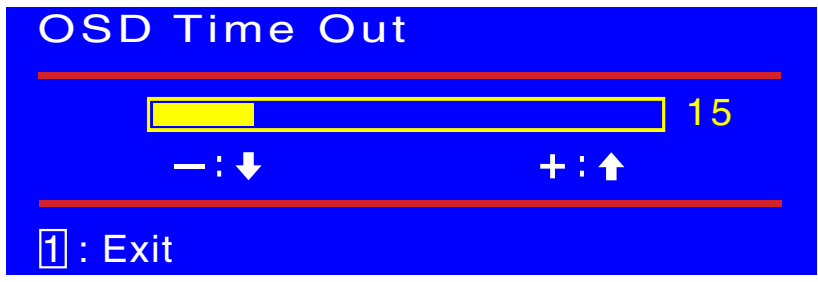





**OSD Time Out:** Sets the length of time the Onscreen Display screen is displayed before exiting.





**Setup Menu**

---

-  Language Select
-  Resolution Notice
-  OSD Position
-  OSD Time Out
-  **Input Select** **Analog**

---

**1** : Exit **2** : Select

**Input Select:** When press Input Select change Input signal to Analog or Digital.

ENGLISH



 **Memory Recall**

**Memory Recall:** Return the adjustments back to factory settings.

Press the button  to select the Memory Recall menu option.

**Audio Menu**

---

-  **Volume**
-  **Mute** off

---

**1** : Exit **2** : Select

**Audio Menu:**

Volume: For adjust speaker output.

Mute: To select the Mute ON/OFF.



## CARE AND MAINTENANCE

### CARE

- Avoid exposing your monitor directly to sunlight or other heat source. Place your monitor away from the sun to reduce glare.
- Put your monitor in a well ventilated area. Do not place anything heavy on top of your monitor.
- Make certain your monitor is install in a clean and moisture-free area.
- Keep your monitor away from magnets, motors, transformers, speakers, and TV sets.

### NOTE

- Move the LCD out of the package and take off the plastic bag and polystyrene Foam.
- Pull the base from Parellel versus panel to vertical.
- Adjust the Panel within 0 degree leaning forward and 20 degree leaning backward. You must bend harder to exceed 20 degree backward but this range is for packing the unit to a small size for storage only.

### CAUTION

Panel exceeding 0 to 20 degree could cause the unit unstable and the harm will be unpredictable.

### SAFETY TIPS

- If smoke, abnormal noise or odor came out of your monitor, switch off the power immediately and call yours service center.
- Never remove the rearcover of your monitor cabinet, The display unit inside contains high-voltage parts and may cause electric shock to human bodies.
- Never try to repair your monitor yourself. Always call your service center or a qualified technician to fix it.

ENGLISH



## TROUBLE SHOOTING

### No Power

- Make sure A/C power is securely connected to the power adapter and the power supply is firmly connected to the monitor.
- Plug another electrical device into the power inlet to verify that the outlet is supplying proper voltage.
- Make sure all short cables are installed.

### Power on but no screen image

- Make sure the video cable supplied with the monitor is tightly secured to the video output port on back of the computer. If not, tightly secure it.
- Adjust brightness

ENGLISH



### Wrong or abnormal colors

- If any colors (red, green, blue) are missing, check the video cable to make sure it is securely connected. Loose or broken pins in the cable connector could cause an improper connection.
- Connect the monitor to another computer.





## APPENDIX

### SPECIFICATIONS

LCD Panel	Driving system	a-Si TFT Active Matrix
	Size	Diagonal: 48.3cm / 19.0"
	Pixel pitch	0.294mm H × 0.294mm V
	Brightness	250cd/m <sup>2</sup> (Typical)
	Contrast ratio	1100 : 1 (Typical)
	Viewable angle	Right / Left : 71 degrees each, Up / Down: 65 degrees (Typical)
	Response time	1 ms (Black, white, black)
Display Colors	Approx.16.2M (6bit+2bit dithering)	
Sync Frequency	Horizontal: 30.0-80.0kHz, Vertical: 50-75Hz	
Dot Clock	135MHz maximum	
Maximum Resolution	1280 × 1024, 1.3 MegaPixels	
Input Connector	D-Sub mini 15 pin DVI-D 24pin	
Plug & Play	VESADDC1/2B™	
Input Sync Signal	Separate sync: TTL, Positive or Negative	
Input Video Signal	Analog: 0.7Vp-p (Standard), 75Ω, Positive Digital: DVI(Digital Visual Interface standard Rev.1.0)compliance	
Input Audio Connector	ø 3.5mm mini jack (Stereo)	
Input Audio Signal	1Vrms maximum	
Speakers	1W × 2 (Stereo speakers)	
Maximum Screen Size	376.3mm W × 301.1mm H / 14.8" W × 11.9" H	
Power Source	100-240VAC, 50/60Hz, 1.5A	
Power Consumption	55W maximum, Power management mode: 2W maximum*	
Dimensions / Net Weight	414.5 × 433.5 × 200.5mm / 16.3 × 17.1 × 7.9" (W×H×D), 5.6kg / 12.3lbs	
Tilt Angle	20 degrees (Up: 0-20 degrees)	
Environmental Considerations	Operating: Temperature 5 to 35°C / 41 to 95°F Humidity 10 to 80% (No condensation) Storage: Temperature -20 to 60°C / -4 to 140°F Humidity 5 to 85% (No condensation)	
Approvals	TCO '99, CE, TÜV-GS / MPRIII (prEN50279) / ISO 13406-2, FCC-B, UL / C-UL, VCCI-B, CCC	

**NOTE** \* Condition: Audio equipment is not connected.



## DIMENSIONS

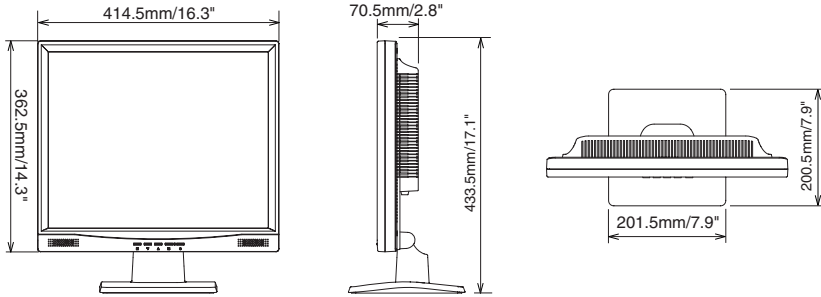

ENGLISH

## COMPLIANT TIMING

Video Mode		Horizontal Frequency	Vertical Frequency	Dot Clock
VESA	VGA 640 × 480	31.468kHz	59.941Hz	25.175MHz
		37.500kHz	74.997Hz	31.500MHz
	SVGA 800 × 600	35.156kHz	56.249Hz	36.000MHz
		37.878kHz	60.317Hz	40.000MHz
		46.875kHz	75.001Hz	49.500MHz
		48.076kHz	72.186Hz	50.000MHz
	XGA 1024 × 768	48.362kHz	60.002Hz	65.000MHz
		56.474kHz	70.067Hz	75.000MHz
		60.024kHz	75.039Hz	78.750MHz
	SXGA 1280 × 1024	63.979kHz	60.029Hz	108.000MHz
79.974kHz		75.024Hz	135.000MHz	
VGA TEXT	720 × 400	31.468kHz	70.086Hz	28.322MHz
Macintosh	640 × 480	35.000kHz	66.667Hz	30.240MHz
	832 × 624	49.724kHz	74.532Hz	57.280MHz





## CONNECTOR PIN ASSIGNMENT

### ■ D-Sub mini 15pin Connector

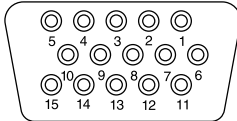

D-SUB

Pin	Input Signal	Pin	Input Signal
1	Red video	9	+5V
2	Green video	10	Ground
3	Blue video	11	NC
4	NC	12	Data line (SDA)*
5	Ground	13	H-Sync
6	Red video ground	14	V-Sync
7	Green video ground	15	Clock line (SCL)*
8	Blue video ground		

\* Compliant to VESA DDC.

### ■ DVI-D 24pin Connector

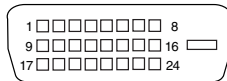

DVI-D

Pin	Input Signal	Pin	Input Signal
1	T.M.D.S Data 2-	13	
2	T.M.D.S Data 2+	14	+5V
3	T.M.D.S Data 2 Ground	15	Ground
4		16	Hot Plug Detect
5		17	T.M.D.S Data 0-
6	Clock line (SCL) *	18	T.M.D.S Data 0+
7	Data line (SDA) *	19	T.M.D.S Data 0 Ground
8	V-Sync	20	
9	T.M.D.S Data 1-	21	
10	T.M.D.S Data 1+	22	T.M.D.S Clock Ground
11	T.M.D.S Data 1 Ground	23	T.M.D.S Clock +
12		24	T.M.D.S Clock -

\* Compliant to VESA DDC.

ENGLISH